

Loading:

Monday – Friday 08:30 to 17:00 (on site by 16:00)
Saturday-Sunday Check

PPE Requirements:



Additional Information:



Reporting/Arrival:

Loading bay



On arrival stop at security



Drive to trailer park
Do not prep trailer until instructed to by P&O Checker



Report to drivers reception with full PPE and loading reference
Wait for instructions.

Loading/Securing:

Stand in green area during loading

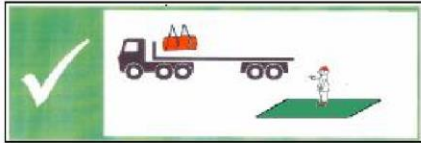

DOORS MUST BE KEPT CLOSED WHEN DRIVING ON SITE

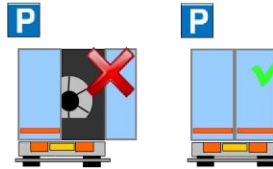

No loose or damaged well boards

Straps LC 2000 daN



No Climbing – Use trailer steps or mobile steps



Clean and tidy trailer bed

Steel Coil Loads:

LOADS MUST BE SECURED IN THE LOADING BAY – PLEASE HAVE STRAPS READY BEFORE ENTERING THE BAY

General coil restraint SYSTEM
Weight limits >10t <24t for low friction coils
and >10t <30t for hot rolled coils

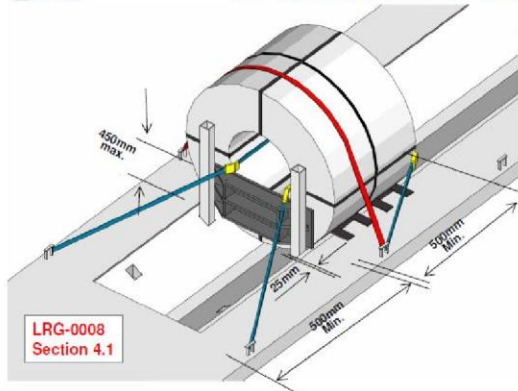

MINIMUM EQUIPMENT REQUIRED:
3 x LC 2000 STRAPS PER COIL – SECURED AS PER DIAGRAM ANCHORED MIN 500mm FROM COIL FACES
EDGE PROTECTION – ON ALL SHARP CORNERS
WELL BOARD – COIL BLOCKED TO MAX 450mm HIGH
2 x STANCHION POSTS

Multiple Stable coils <

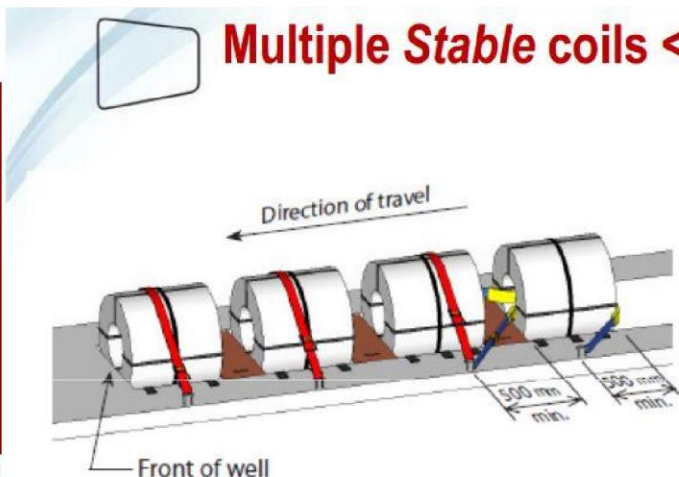

Loading:

Monday – Friday 08:30 to 17:00 (on site by 16:00)
Saturday-Sunday Check

PPE Requirements:



Additional Information:



Reporting/Arrival:

Loading bay



On arrival stop at security



Drive to trailer park
Do not prep trailer until instructed to by P&O Checker



Report to drivers reception with full PPE and loading reference
Wait for instructions.

Loading/Securing:

Stand in green area during loading

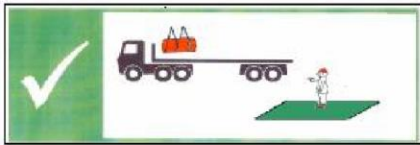

DOORS MUST BE KEPT CLOSED WHEN DRIVING ON SITE

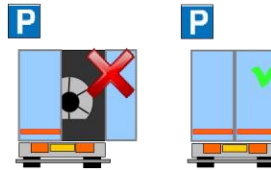

No loose or damaged well boards

Straps LC 2000 daN



Clean and tidy trailer bed

Steel Sheet Pack (AFL) Loads:

LOADS MUST BE SECURED IN THE LOADING BAY – PLEASE HAVE STRAPS READY BEFORE ENTERING THE BAY

4. Overview of restraint system - export loads



14 Straps & Ratchets required



Edge protection is required

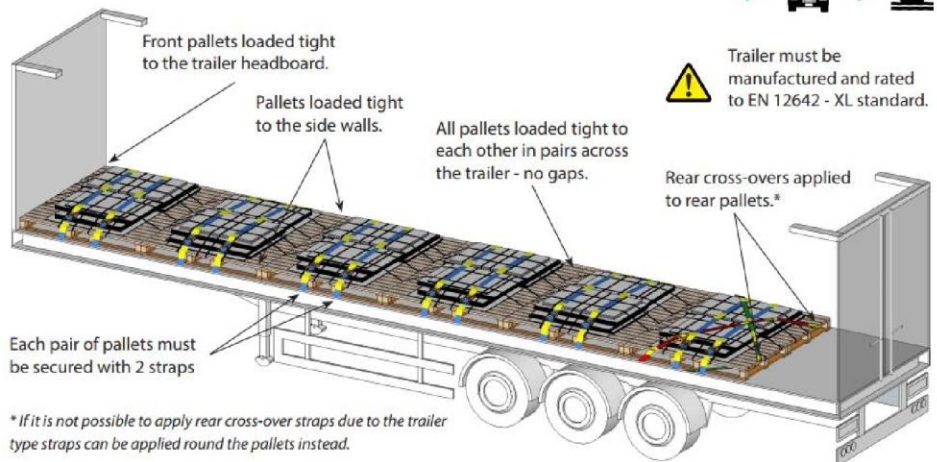

Trailer must be manufactured and rated to EN 12642 - XL standard.

*If it is not possible to apply rear cross-over straps due to the trailer type straps can be applied round the pallets instead.