



British Steel, Scunthorpe REDBOURN Steel Sections using Chains Collection Plan Flatbed

Loading:

Monday – Friday 0800-1500

PPE Requirements:



Additional Information:



Reporting/Arrival:



ON ARRIVAL STOP AT VISITOR CENTRE GATE **A**

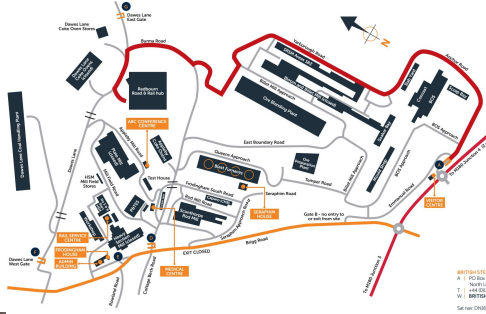

REDBOURN HUB DRIVER RECEPTION

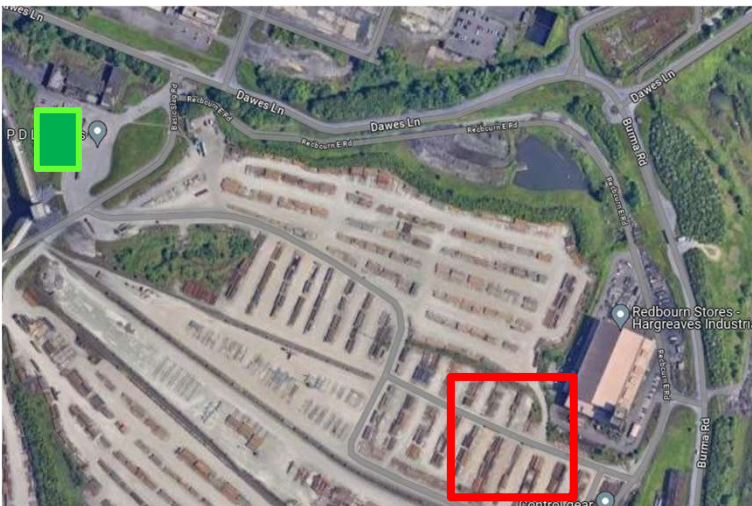

Loading/Securing:

Stand in **GREEN** area during loading

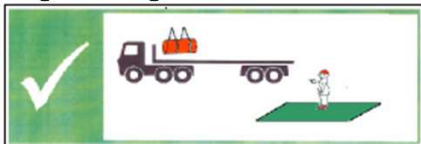

NO CLIMBING! USE PLATFORM WHERE PROVIDED!

Max X 7



Max X 10



Recommended 6 pairs



LOADS MUST BE SECURED IN THE LOADING AREA – PLEASE HAVE ALL EQUIPMENT READY

LOADS MUST BE SECURED IN THE SECURING AREA – PLEASE HAVE ALL EQUIPMENT READY

SECURING INFORMATION ON REVERSE

LRG 002 Sections using Chains

1. This guideline applies to:

- Structural sections as listed below, loaded web horizontal in vertical tiers on timber dunnage.

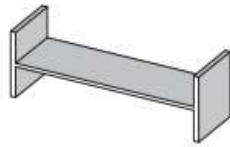

Universal beams

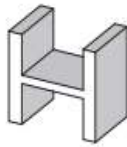

Universal columns

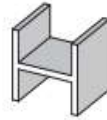

Universal bearing piles



Parallel flange channels

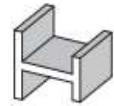

Asymmetric beams

- Mill finish steel-on-steel static coefficient of friction $\mu_s = 0.42$; tested according to EN 12195-1:2010 Annex C.

Note: If steel is painted or galvanised it is classed as low friction and additional restraint is required.

2. Essential requirements

- All restraints must be transport chains compliant with EN 12195-3:2001 (Grade 8 chain).
- Base dunnage must be a single layer of square section timber.
- Minimum 4-off base dunnage on standard trailers and 5-off on extendable trailer
- Side pins. 6-off recommended. (Omitted for clarity on some images).

Minimum 2 x Belly wrap Chains for All Irish Loads (see TIS 001) ✓

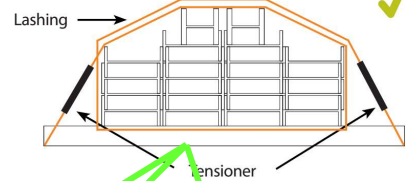

3. Overview of restraint system

Full load (28 tonnes) on a standard trailer restrained using 8mm chains:

- ✓ 3 belly-wrapped and 4 **over-the-top** chains.
- ✓ Restraints are a minimum of 500mm from front and rear of product.
- ✓ Restraints are placed close to dunnage.
- ✓ 4-off square section timber dunnage.
- ✓ Side pins.

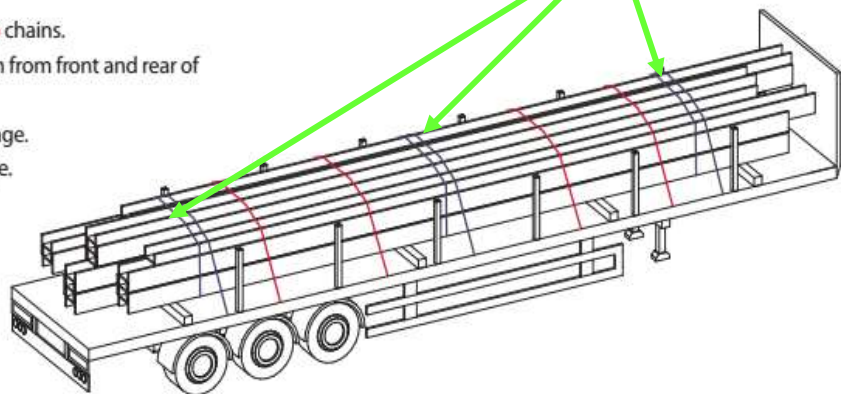

Table 1: 8mm chains (4-tonne lashing capacity)

Load	Belly-wrap		Over-the-top		Total
0-10 t	3	+	0	=	3
10-15 t	3	+	1	=	4
15-20 t	3	+	2	=	5
20-25 t	3	+	3	=	6
25-28 t	3	+	4	=	7

Table 2: 10mm chains (6.3-tonne lashing capacity)

Load	Belly-wrap		Over-the-top		Total
0-10 t	2	+	0	=	2
10-15 t	2	+	0	=	2
15-20 t	2	+	1	=	3
20-25 t	2	+	2	=	4
25-28 t	2	+	3	=	5

This Load Restraint Guideline is designed to be compliant with the forces stated in EN 12195-1:2010 and VDI 2700.

Overview of Redbourn Prairies

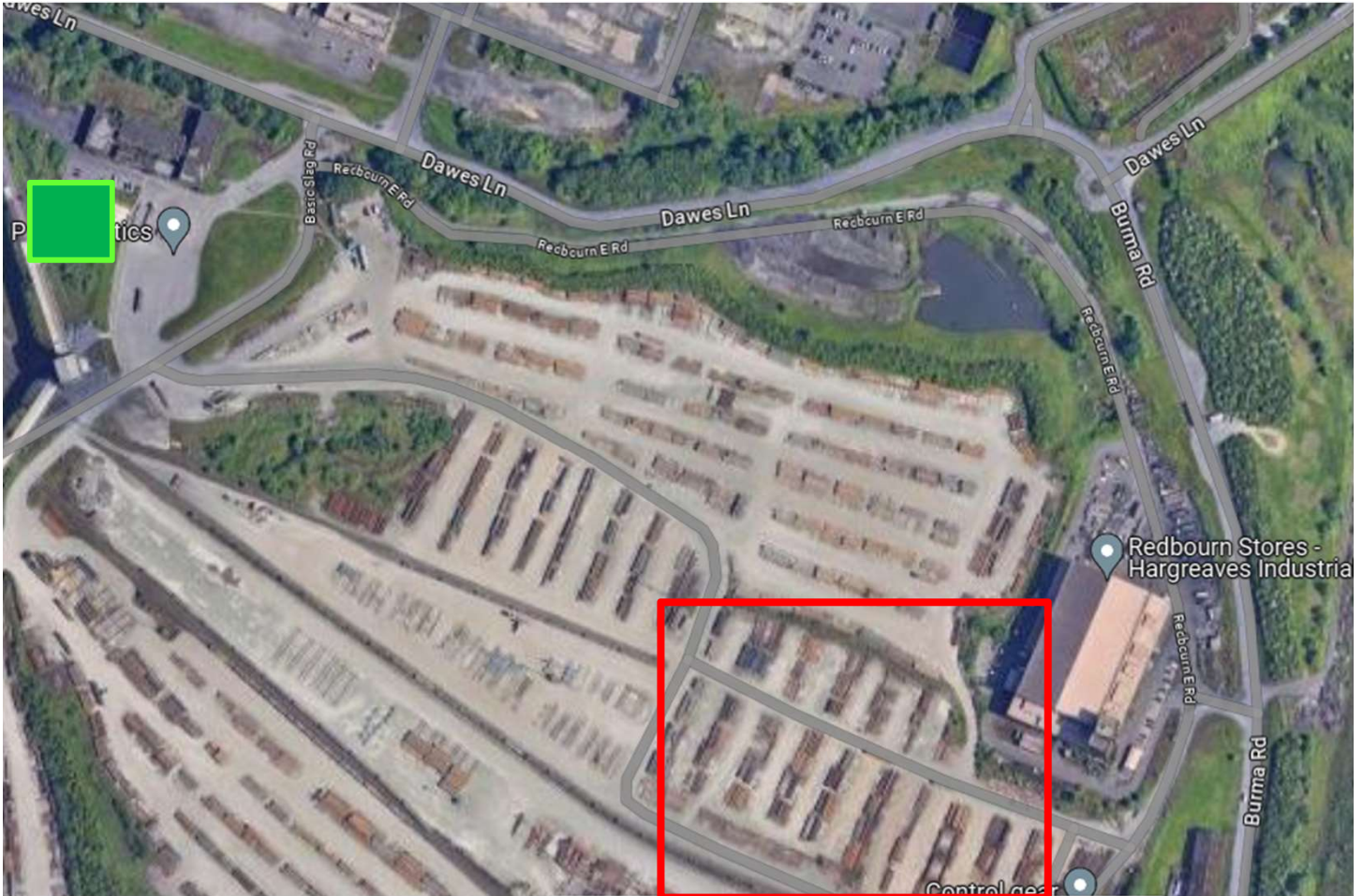

Book IN/ OUT

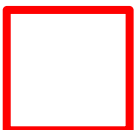

General Sections Loading/ Chaining Area.

If required to move, apply a minimum 2 shunt chains and transit to area near to the Booking In office and complete chaining to the LRG standard.

DON'T FORGET THE BELLY WRAP CHAINS FOR ALL LOADS